

Utz Pallets

Take the strain in any situation.

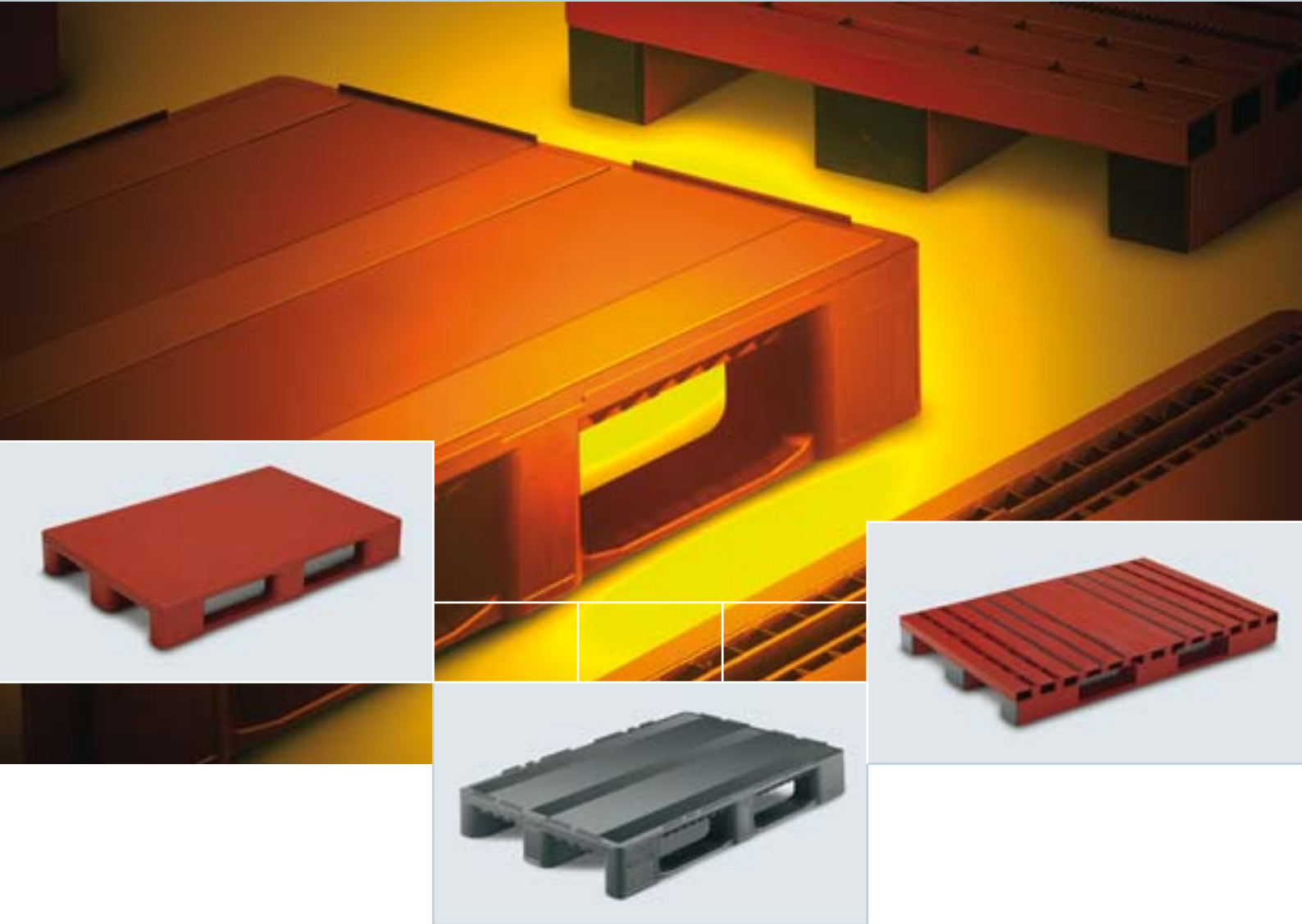

**Materials Handling
in Plastic**

UPAL-H

Clean, robust
and fully sealed.

- ✓ Constant tare weight.
- ✓ High load capacity.
- ✓ Acid- and alkali-resistant.
- ✓ Metal reinforcement for additional loading.
- ✓ Increased suitability for high-bay racking.
- ✓ Easy to clean.
- ✓ Unrivalled in the food, hygiene and clean-room sector.
- ✓ Increased load-safety through deck variations.
- ✓ Anti-slip deck as optional extra.
- ✓ Forklift safe and compatible.
- ✓ Long life-span and recyclable.

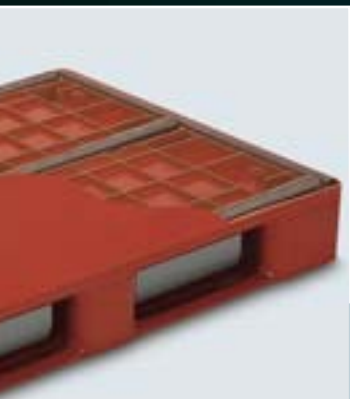

Metal reinforcement

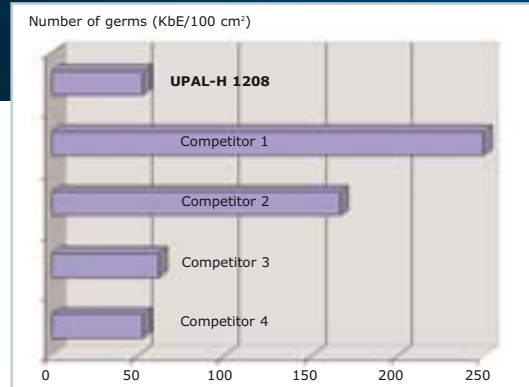

The UPAL-H is a true hygiene pallet
At a neutral testing laboratory, the UPAL-H 1208 and four competitive pallets were inoculated with various germs. The diagram shows the remaining average number of germs on the pallet after cleaning.

Load capacity (at 23°C room temperature)				
UPAL-H	800x600	1200x800 + 1200x1000		
		non-reinforced	partially reinforced	fully reinforced
static	3000 kg	6000 kg	6000 kg	7500 kg
dynamic	750 kg	1500 kg	1500 kg	1500 kg
racked	500 kg	500 kg	variable*	1300 kg

*= Depending on the number of the metal reinforcement and their wall thickness, the load capacity may vary. - We recommend testing of the pallet before its use.

Smooth

Continuous safety edge

Interrupted safety edge



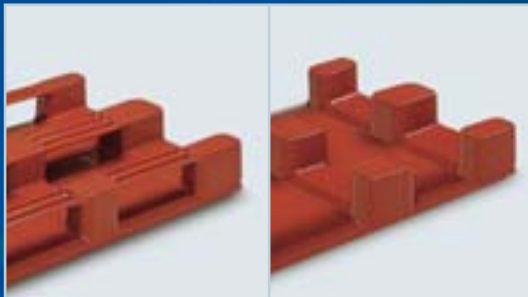
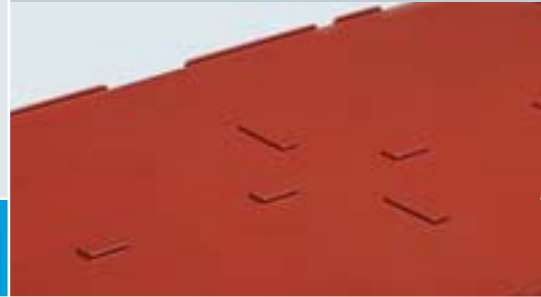

Interrupted safety edge with center fixing



3 longitudinal runners

9 feet

Pallet	Base construction	Deck construction				
			smooth	continuous safety edge	interrupted safety edge	
					with center fixing	without center fixing
UPAL-H 800x600x160 mm 	3 runners	non reinf.	33-8060-630R	33-8060-632R	33-8060-636R	33-8060-642R
		part. reinf.	—	—	—	—
		fully reinf.	—	—	—	—
UPAL-H 1200x800x160 mm 	3 longitudinal runners	non reinf.	33-1208N-630-0000	•	•	33-1208N-642-0000
		part. reinf.	33-1208N-630-0200	•	•	33-1208N-643-0200
		fully reinf.	33-1208N-634-0500	33-1208N-635-0500	•	•
	9 feet	non reinf.	33-1208N-600-0000	•	•	•
		part. reinf.	•	•	•	•
		fully reinf.	•	•	33-1208N-609-0000	•
UPAL-H 1200x1000x160 mm 	3 longitudinal runners	non reinf.	33-1210-630R	•		33-1210-642R
		part. reinf.	•	•		•
		fully reinf.	•	33-1210-635R		
	9 feet	non reinf.	33-1210-600R	•		•
		part. reinf.	•	•		•
		fully reinf.	33-1210-634R	•		•

■ = Stock items

• = Special pallet configurations and colours are available on request.

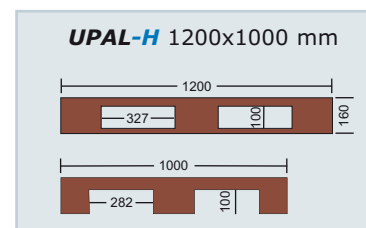
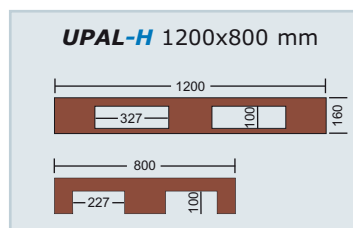
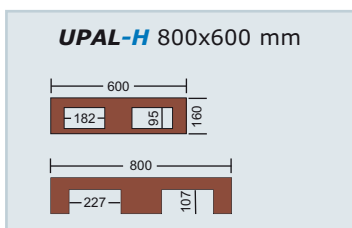

UPAL-S

Clever, flexible and suitable for racking.

Without safety edge

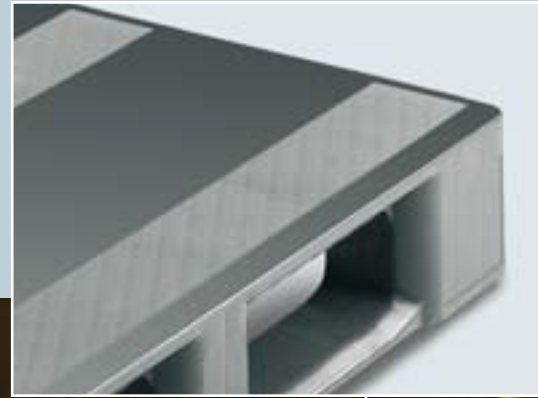

- ✓ **Constant tare weight.**
- ✓ **High load capacity.**
- ✓ **Metal reinforcement for additional loading.**
- ✓ **Increased suitability for high-bay racking.**
- ✓ **Electro-conductive option.**
- ✓ **Increased load-safety through deck variations.**
- ✓ **Anti-slip deck as optional extra.**
- ✓ **Forklift safe and compatible.**
- ✓ **Long life-span and recyclable.**



Metal reinforcement



Without reinforcement



Internal safety edge,
interrupted once



Internal safety edge,
interrupted several times



External safety edge, continuous



Pallet	Base construction	Deck construction				
		continuous safety edge			external safety edge	
		without	interrupted once	interrupted several times	continuous	
UPAL-S 1200x800x160 mm 	3 runners	non reinf.	33-1208S-630-02	33-1208S-730-02	33-1208S-530-02	33-1208S-930-02
		fully reinf.	33-1208S-630-01	33-1208S-730-01	33-1208S-530-01	33-1208S-930-01

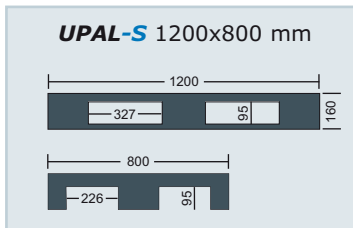

Load capacity (at 23°C room temperature)		
UPAL-S	1200x800 non reinf.	1200x800 fully reinf.
static	6000 kg	7500 kg
dynamic	1500 kg	1500 kg
racked	500 kg	1300 kg

We recommend testing of the pallet before its use.



3 runners

UPAL-I

Robust, high load capacity,
with various uses.

- ✓ Constant tare weight.
- ✓ High load capacity.
- ✓ Anti-slip deck as optional extra.
- ✓ Safe handling.
- ✓ Forklift safe and compatible.
- ✓ Long life-span and recyclable.



Load capacity (at 23°C room temperature)

UPAL-I	800x600	1200x800	1200x1000
static	3000 kg	4000 kg	5000 kg
dynamic	750 kg	1000 kg	1500 kg
racked	500 kg	500 kg	500 kg

We recommend testing of the pallet before its use.





3 runners

2 runners and 3 feet

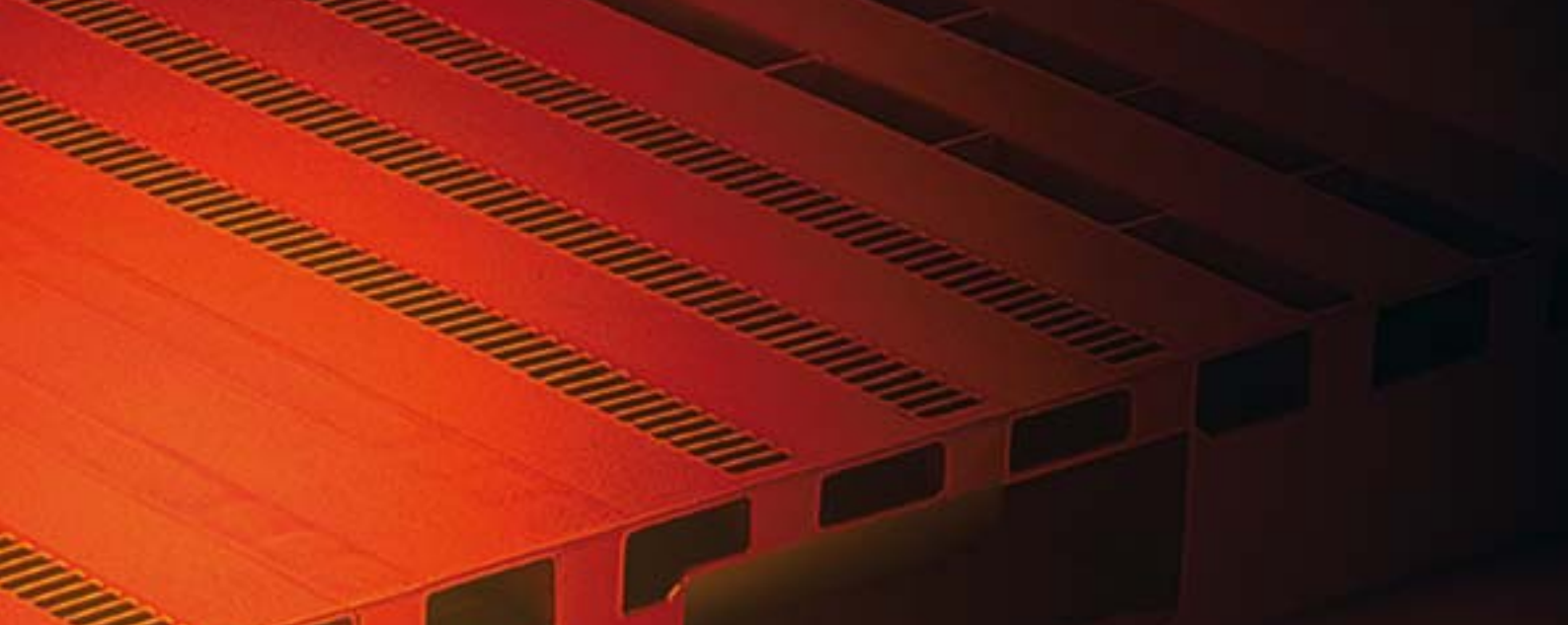
9 feet



Pallet	Base construction	Deck construction				
		perforated, smooth		safety edge		
		without anti-slip	with anti-slip	interrupted	continuous	
UPAL-I 800x570x150 mm 	3 runners	non reinf.	33-604-57R	●	—	—
UPAL-I 1200x800x150 mm 	3 runners	non reinf.	33-604R / 33-604 EL	33-604-004R	—	—
UPAL-I 1200x1000x150 mm 	2 runners and 3 feet	non reinf.	33-661R	●	33-661-2R	33-661-3R
	runners on all sides	non reinf.	33-662R	●	●	●
	9 feet	non reinf.	33-663R	●	●	●

■ = Stock items

● = Special pallet configurations and colours are available on request.

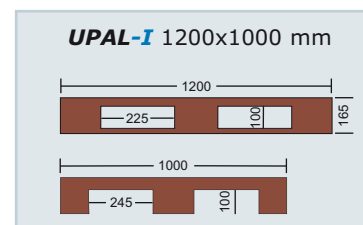
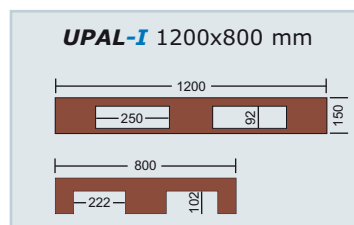
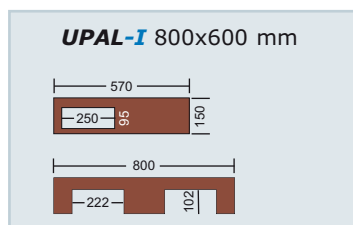

UPAL-H UPAL-S UPAL-I

Options, special designs and other models.

Pallet-dimensions, it's your choice:

With half-size, Euro and ISO pallets available, the possibilities are endless.

For example, the attachment of an Utz Euro-sized pallet with our half-sized pallet will give an 1800x800 mm version.

The joining of two Euro-pallets will produce a double-pallet 1600x1200 mm.

What further pallet-dimensions could you require?

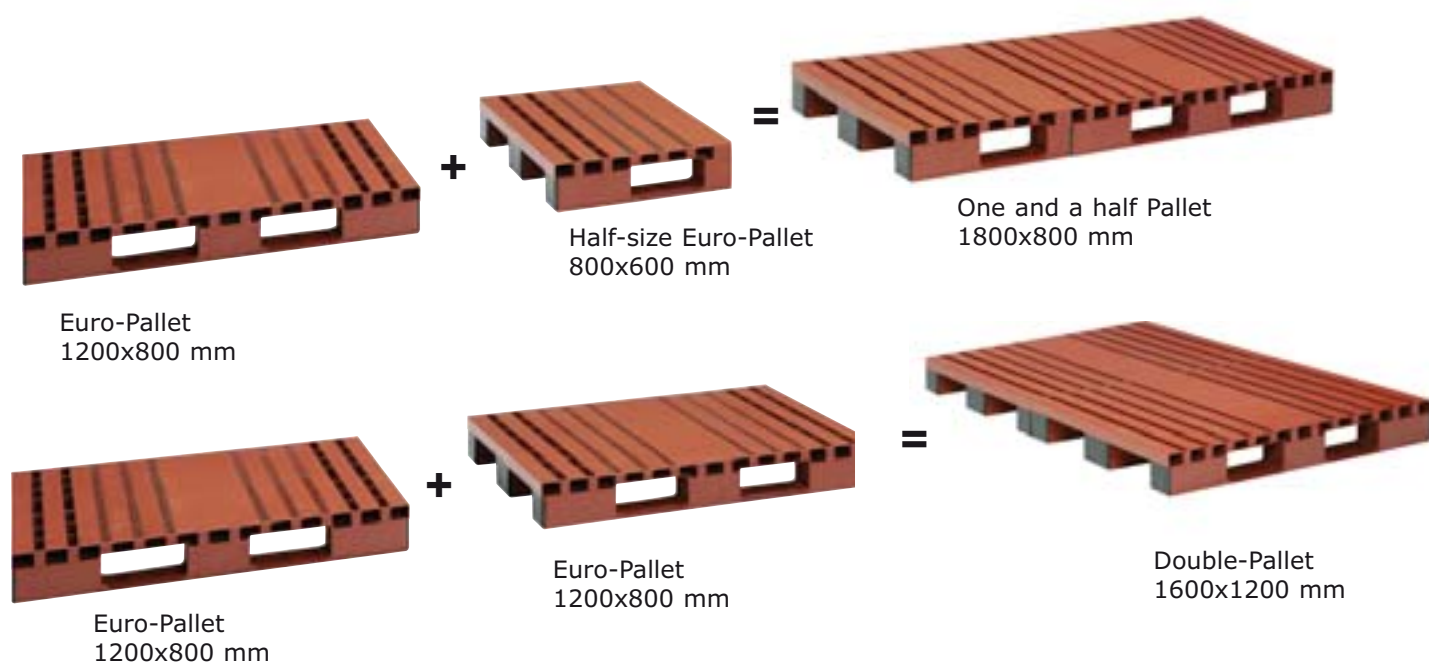

UPAL-H EL 1200x800 mm



UPAL-S EL 1200x800 mm



Electrically conductive Pallets

Nearly all Utz pallets are also available in an EL - electrically conductive - version.

UPAL-I EL 800x600 mm / 1200x800 mm

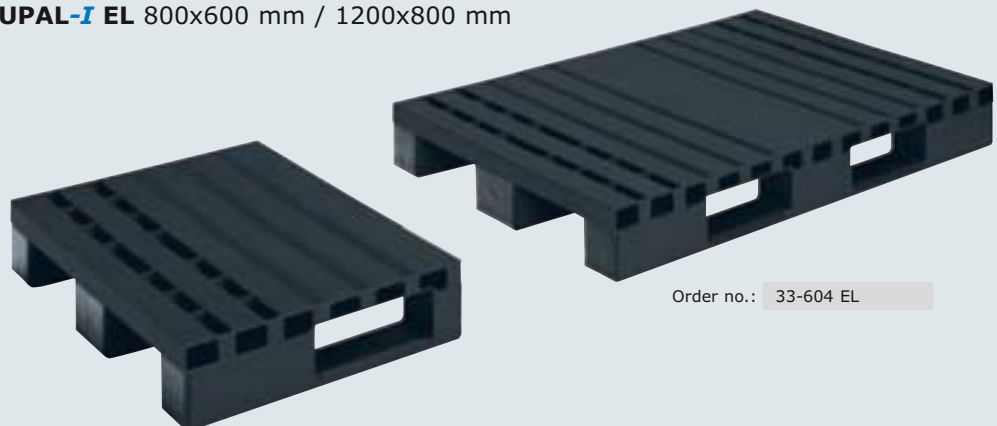

Order no.: 33-604 EL

UPAL-H UPAL-S UPAL-I

Accessories, extras and additions.

Utz pallets keep their load:

It is always possible for a load to slide on a slippery pallet deck. That's why Utz pallets can also be provided with an anti-slip surface - whether it be a complete Elastomer or grip paint coating, or simply anti-slip stripes.



Elastomer paint

Elastomer-coated stripes on the deck

Grip paint

Safety edge as slip protection



Slip-resistance test with containers (load 15 kg)

Elastomer paint (from an angle of 27°, the container begins to slip down slightly; from an angle of 46°, the container slides away).

Quartz sand coating (angle 32°)

Grip paint (angle 26°)

Wood pallet (angle 25°)

With safety edge (until the container topples over)

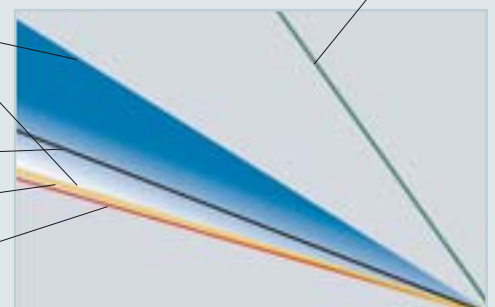

Would you like to recognise your pallets as yours?

This is possible with mould inserts or a printed logo of your choice.



Mould inserts



Pad printing



Covers are also available in electro-conductive material.

Covers	For pallet size	Ext. dimensions	Order-no.
	800x600 mm	810x610 mm	3-223U-0
	1200x800 mm	1210x820 mm	20-0751
	1200x800 mm	1204x807 mm	40-1208
	1200x1000 mm	1210x1010 mm	21-0780-1
	1200x1000 mm	1204x1006 mm	40-1210-0

 = Stock items



Compact transport units on a stable base:

Utz pallets are robust carriers, for which we are not only able to supply covers in various sizes, but also accessories to make complete unit loads even safer.

Even electronic identification of pallets and load is made simple.

RFID-Tags or barcode labels can be welded or applied to the pallets.



Georg Utz GmbH
Nordring 67
D-48465 Schüttorf
Phone +49 (0) 59 23 805 0
Fax +49 (0) 59 23 805 800
info@de.georgutz.com

Georg Utz Sarl
Zone d'activités les 2B
Parc Actipole 2
F-01360 Bressolles
Phone +33 (0) 4 37 85 83 00
Fax +33 (0) 4 37 85 83 09
info@fr.georgutz.com

George Utz Ltd.
Grange Close
Clover Nook Industrial Estate
GB-Alfreton DE55 4QT
Phone +44 (0) 1773 543 170
Fax +44 (0) 1773 543 180
info@uk.georgutz.com

Georg Utz Sp.z o.o.
Nowowiejska 34
PL-55-080 Katy Wrocławskie
Phone +48 (0) 71 316 77 60
Fax +48 (0) 71 316 77 61
info@pl.georgutz.com

Georg Utz Inc.
4675 Andrews Street
Columbus, IN 47203-1812 USA
Phone +1-812-372-2790
Fax +1-812-372-2796
info@us.georgutz.com

**Georg Utz Materials Handling
(Suzhou) Co., Ltd.**
369 Lushan Road, Building No 36
Suzhou 215129 • Jiangsu / China
Phone +86 (0) 512 6667 0998
Fax +86 (0) 512 6667 0697
info@cn.georgutz.com

POOLTEC AG
Fischbacherstrasse 11
CH-5620 Bremgarten
Phone +41 (0) 56 648 21 11
Fax +41 (0) 648 21 19
info@ch.georgutz.com

www.georgutz.com

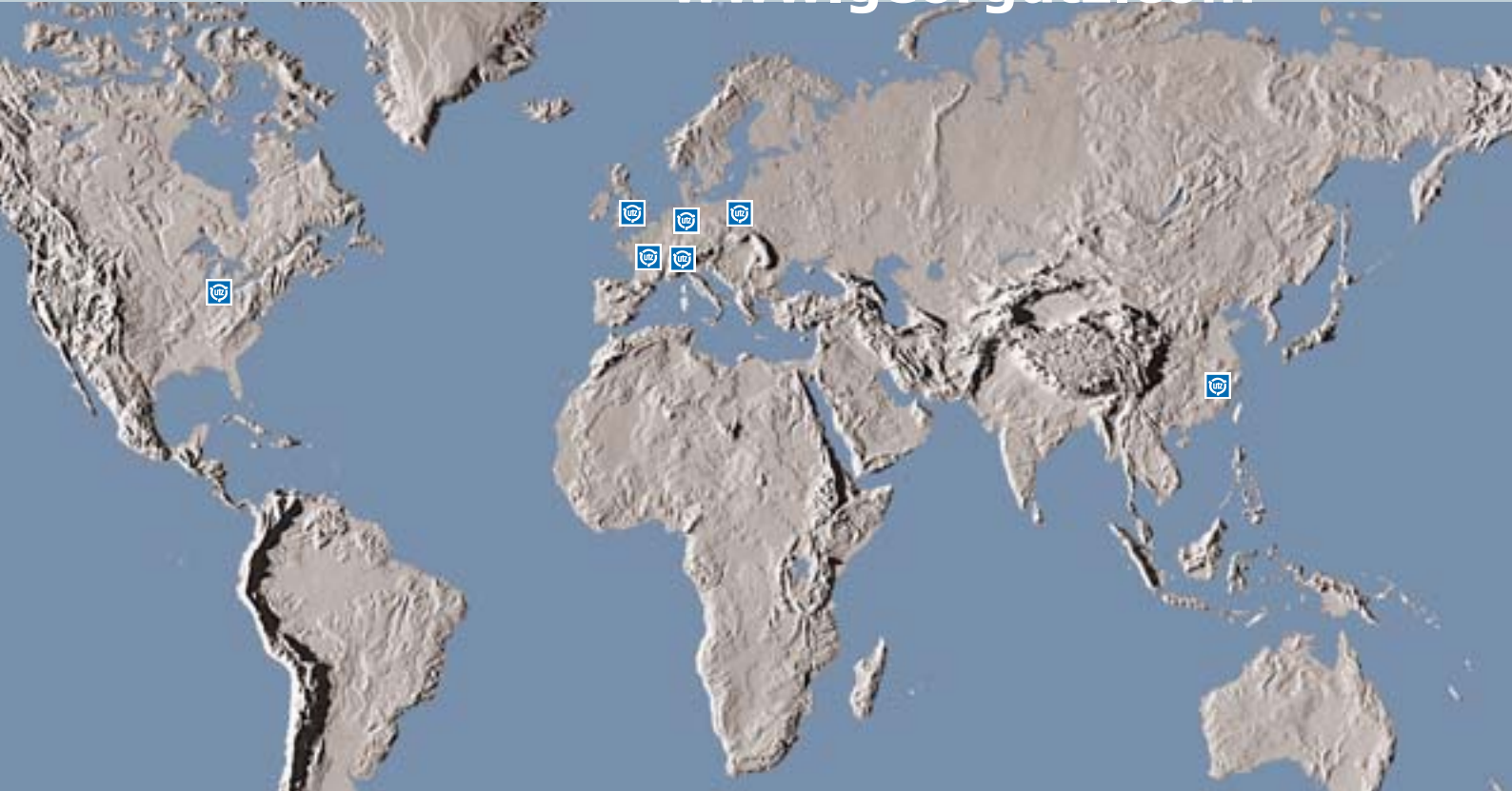

Georg Utz AG
Au graben 2-4
CH-5620 Bremgarten
Phone +41 (0) 56 648 77 11
Fax +41 (0) 56 648 79 12
info@ch.georgutz.com



**Materials Handling
in Plastic**